

Artificial Metal-Based Muscle for Long Stroke Actuators

BioMetal Helix
BMX series

The BioMetal Helix (BMX Series) is a biometal micro coil. It is a linear actuator (linear-motion drive unit) featuring wide-range expansion and contraction. At room temperature, it is soft and can be elongated with ease. The BMX, elongated at room temperature, becomes stiff and sharply contracts to its original length when a current is fed through it. It is again softened by stopping the flow of current. It also contracts if heated by hot air. The BMX produces a by far greater force when it contracts than does it when it extends at room temperature. The change in length is nearly 200% of the length of the contracted BMX. It can be repeatedly used any number of times. It is ideally suited for millimeter and micrometer size actuators for use in narrow spaces where it is impossible to use motors and pneumatic cylinders.

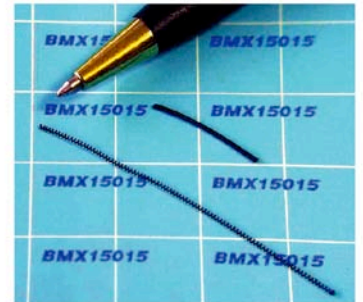

Features of the BMX Series

Long stroke and production of strong force

A remarkably long stroke, 100%-200% of the length of the contracted BMX. Although being a very thin actuator, this product produces a very strong force. Since a wide-range movement can be brought by its simple mechanism, it can be easily incorporated into the design of systems for a wide variety of applications.

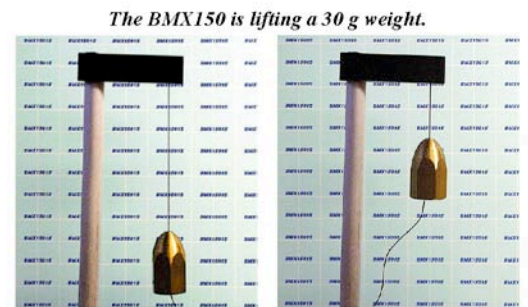

The BMX150 is lifting a 30 g weight.

Wide-range movement of the BMX.

Smooth, pliable operation

The BMX moves without generating any vibration or sound. Unlike the solenoid (electromagnet), it produces the greatest force at the start point and the force produced changes only slightly over the long displacement interval. Its capability can be fully utilized when it is used for the resetting mechanism of latches and locks and for micro servo actuators.

The force produced by the BMX is the strongest at the start and it changes only slightly.

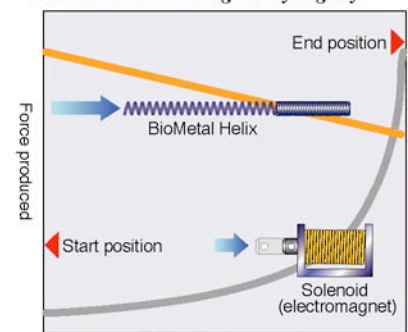

Stroke (displacement)

Operation at low voltage and low power

The BMX can be moved merely by connecting it to a cell after stretching it lightly. No special drive circuit is necessary. It can be safely used because it can be driven by a low voltage. The drive current required is very small. Fine adjustment of motion can be made by using a PWM power control circuit. The BMX, which moves responding to temperature changes, can also be utilized as a thermostat-like actuator. Needless to say, it can also be moved by heating it by a hot air blower.

Ideal for milli and micro size mechanisms

The force produced by the BMX is directly proportional to its cross-sectional area. Although small in size, the BMX is capable of producing a strong force and less susceptible to friction and viscosity than motors and solenoids.

The BMX's material itself is an actuator. It can be used even when cut short. Since being small, thin, and simple in construction, it is ideally suited for use in milli and micro size mechanisms. It is the only powerful actuator available that can be incorporated in thin IC cards and chips.

The BMX operates at low voltage.

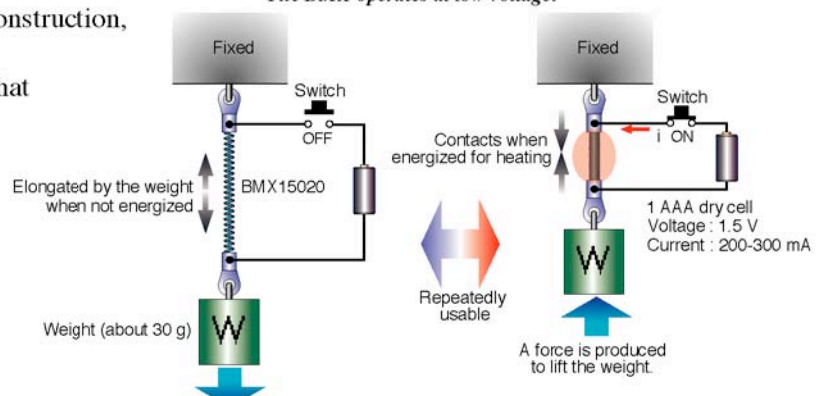

BioMetal Helix BMX series

Applications of the BMX Series

- Ultra-small actuators
- Ultra-thin actuators
- Ultra-small temperature switches
- Flexible actuators
- Actuators for toys and models

Basic uses of the BMX

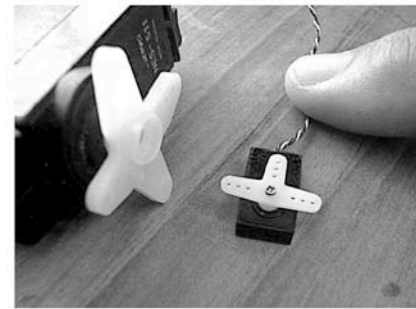
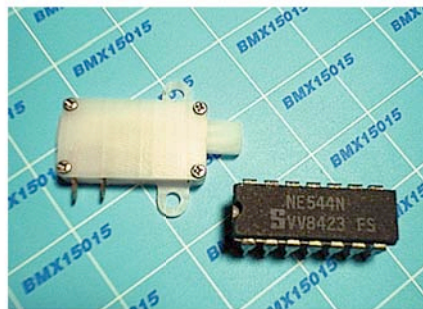
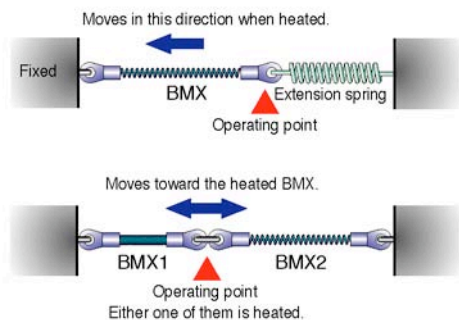

NOTE: The BMX series is not suited for the following applications.

- Applications where high-speed repetitive operations are required (The BMX can move at high speed only in the contracting direction.)
- Movement of a heavy load
- Mechanism of a size allowing the use of a motor
- Applications where the temperature can rise to above 55°C
- Prolonged use in water
- ※ Where high reliability in produced force and service life is required, consider using the BioMetal Helix BMX series.

Major Characteristics and Specifications of the BMX Series

	BMX50	BMX75	BMX100	BMX150
Standard coil diameter D (mm)	0.2	0.32	0.4	0.62
Wire diameter d (mm)	0.05	0.075	0.1	0.15
Coil diameter-to-wire diameter ratio D/d	4.0	4.3	4.0	4.1
Practical maximum force produced (gf)	3~5	5~10	10~20	20~40
Kinetic displacement (change in length) (%)	200	200	200	200
Standard drive current (mA)	50~100	70~120	100~150	200~300
Standard electric resistance (Ω/m)	3600	1600	900	400
Allowable upper temperature limit (°C)	—	—	—	50~60
Service life (times)	—	—	—	10 ⁶

- *The number following BMX in the product name is the value of its diameter expressed in micrometer. For example, the BMX100 has a diameter of 0.1 mm. For any type of BMX, the coil diameter-to-wire diameter ratio is about 4.
- *The BMX is uniform in the longitudinal direction. For this reason, most of the numerical data in the table are determined with reference to the unit length (1 m) of the BMX.
- *The kinetic distortion is represented by the ratio in percentage of the displacement (contraction or expansion) of the BMX to its total length.
- *The numerical data in the table are standard values used as a guide for device design. The actual performance characteristics may differ from them, depending on the operating conditions.
- *The numerical data in the table are not guaranteed values but reference values. The actual numerical data may be varied by improvement of the BMX. There are also slight variations between lots.

- The service life of the BMX is closely associated with the magnitude of the load and the kinetic distortion. It has a track record of having made more than five million reciprocating motions under appropriate load and movement conditions (Example: BMX150. Eight million motions completed at the load of 30 gf and at the kinetic distortion of 50%.)
- The BMX makes non-linear, asymmetric motions (contractions and expansions). It can be quickly contracted if it is heated in an adiabatic manner by feeding a large current through it. However, it cannot be quickly elongated without forced cooling because the rate of elongation depends on cooling speed. In the case of self-cooling the BMX is affected by the ambient temperature and the wind. The data shown in the table below those obtained at the room temperature of 20°C under the windless condition.
- The upper limit of operating temperature varies with the load condition. This limit can be increased to some extent by increasing the bias. In that case, however, the service life of the BMX may be shortened. There is no lower limit of operating temperature. The current required for driving by heat increases with decreasing ambient temperature.

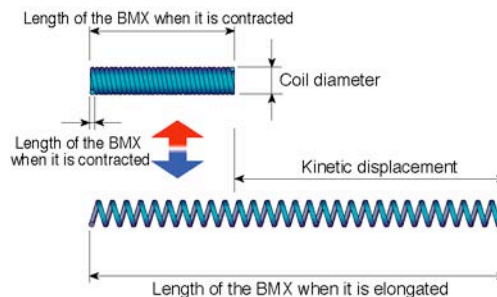

Thickness comparison between BMXs

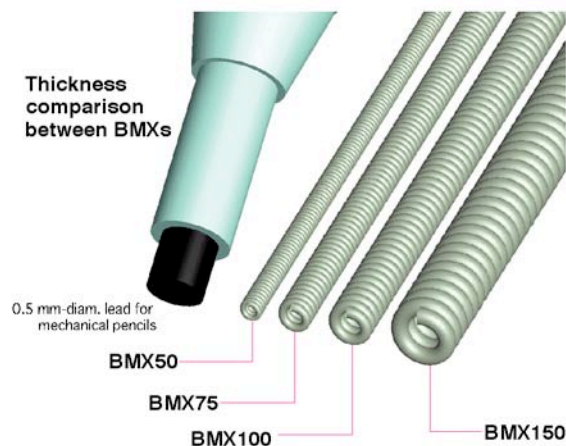

Line-up of BioMetal Helix BMX Series Sample Set

Product No.	Coil diameter
BMX5020	φ 0.20mm
BMX7520	φ 0.32mm
BMX10020	φ 0.40mm
BMX15020	φ 0.62mm

CONTENTS
 BioMetal Helix each 20 mm, 1 pc.
 Instruction manual
 Biasing spring 4 pcs.
 Small-size spectacle terminal 16 pcs.
 Ultra small-size eyelet terminal 16 pcs.